

ACTIONPAC LNS5 & SAFEGARD V5 Panel Installation Datasheet



ELECTROSTATIC SENSITIVE DEVICE

This product forms part of a life safety system. Failure to correctly store, handle, install and maintain the product will directly put at risk the lives of the occupants and the fabric of the building.



ALWAYS READ THIS DOCUMENT BEFORE
INSTALLATION. PLEASE RETAIN FOR
FUTURE REFERENCE.



Mounting

- Only use the mounting brackets provided.
- The height of the unit above the floor level should be chosen so that the centre of the PC is just above normal eye level (approximately 1.5 m).
- The unit should be placed in a naturally vented area and this area should be considered fire safe and free from high levels of shock and vibration.
- Conditions should not arise which may allow the temperature in this area to reach or exceed the operating temperature of the unit.
- Do not locate the unit where access to its internal components and connections are restricted.
- Flush mounted panel option available.

WARNING: Observe all health and safety procedures when lifting or moving this equipment.

Preparation

- Only trained and qualified personnel should be allowed to install, replace or service this equipment. Installation should be in accordance with the relevant local safety standards.
- The mains wiring should comply with IEC 60227 or IEC 60245.
- A switch or circuit breaker should be included as part of the installation.
- The switch or circuit breaker should meet the relevant requirements of IEC 60947-1 and IEC 60947-3.
- The switch or circuit breaker should be in close proximity to the equipment and be within easy reach of the operator.
- The switch or circuit breaker should be marked as the disconnecting device for the equipment and should disconnect both poles of the supply.
- The switch or circuit breaker should not interrupt the protected earth conductor.
- This equipment **MUST** be earthed.

Mounting Diagram

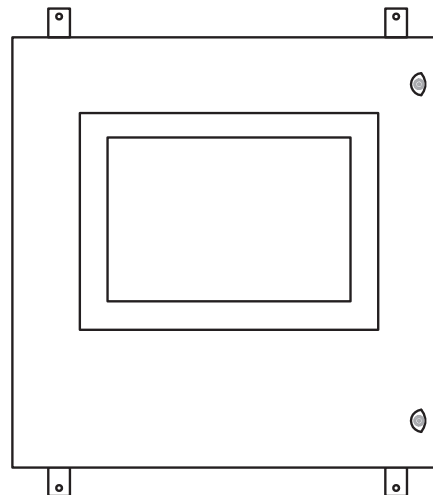

Panel sizes & weights

There are 5 panel sizes as standard

	H x W x D(mm)	Approx weight	Handling
Size 1:	500 x 500 x 210	15 kg	One person
Size 2:	600 x 600 x 210	25 kg	Two people
Size 3:	800 x 800 x 210	40 kg	Three people
Size 4:	1000 x 800 x 300	55 kg	Forktruck
Size 5:	1200 x 800 x 300	65 kg	Forktruck

Wire mains supply feed in right hand side of top gland plate

UPS Batteries

Control panels fitted with a Phoenix Contact battery are supplied with battery fuses removed and cable tied to the battery for installation prior to power being turned on. These batteries leave Safeguard fully charged.

Should the panel be placed in storage for more than 4 months, it is recommended that the power be applied to the panel to allow the battery charge to be maintained.

Installation

1. Disconnect the local supply before commencing any work on this equipment.
2. Wire the mains supply feed in accordance with wiring diagram 1. When complete, secure the mains cable using the cable gland.
3. Wire the incoming mains cable in accordance with wiring diagram 2.
4. Wire the incoming live (brown) and neutral (blue) wires to the mains terminal.
5. Connect the incoming earth (green and yellow) wire to the protected earth stud using a ring connector. This connector must be fitted and secured independently using the shake proof washer and nut provided. The floating panel earth wire should be connected on top of this using the additional shake proof washer and nut provided.
6. The mains cable should be fitted in such a manner that, should the cable be subject to strain, the earth wire would be the last wire to break loose.
7. Finally, the mains wires should be tie wrapped to prevent slippage. Once wiring is complete, apply power to the equipment.

Wiring Diagram 1 (Mains supply feed)

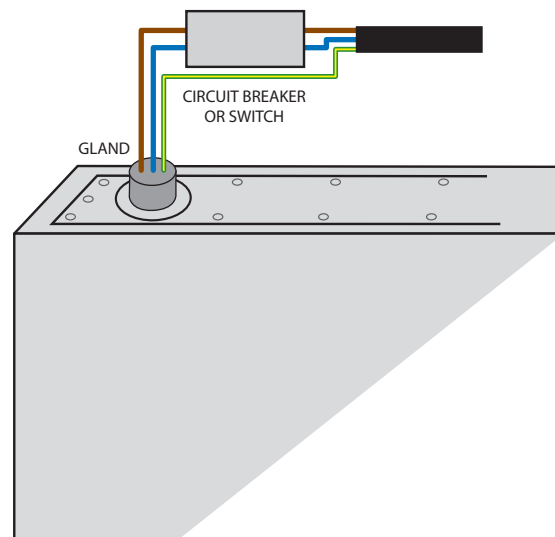

Wiring Diagram 2 (Incoming mains cable)

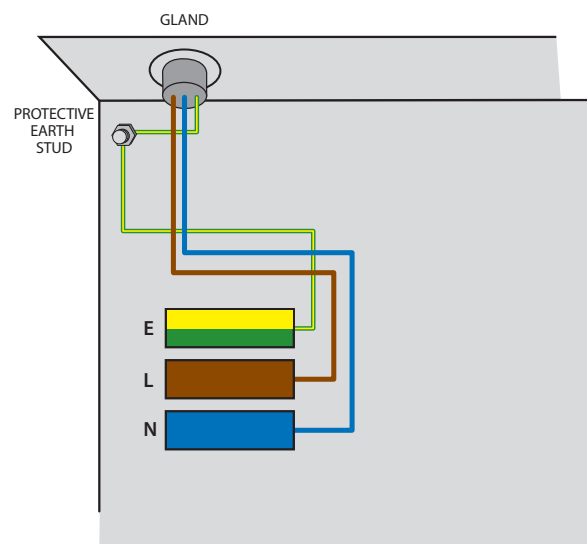



Inputs

- The volt free input terminals are numbered 201, 202, 203, etc.
- Wire the first input as shown across and repeat for subsequent inputs.
- Please note that inputs are not optically isolated.
- The input cable diameter should be 1mm^2 or 1.5mm^2
- Limit cable runs to 100m and avoid running input cables near sources of mains or noisy environments.

Input Wiring

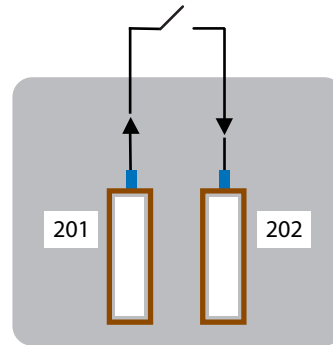

INPUT	TERMINAL NUMBER
INPUT 1	201, 202
INPUT 2	203, 204
ETC.	

Outputs

- The relay output terminals are numbered 401, 402, 403, etc.
- Wire the first output as shown across and repeat for subsequent outputs.
- It is the user's responsibility to ensure the switched equipment is adequately protected.
- As a precautionary measure, a standard 1AT fuse is used to protect each output irrespective of it switching 24 V or mains. The value of this fuse may have to be modified in accordance with the user's requirements. The user is responsible for the replacement policies of any fuses whose value deviates from the standard 1 AT fuse supplied.
- The non-fused terminals 401, 403, 405, etc. should be regarded as the output terminals to the switched equipment.
- The fused terminals 402, 404, 406, etc. should be regarded as the input terminals from the switched equipment. The two terminal wires from each output should be tie wrapped together to prevent slippage.

Output Wiring

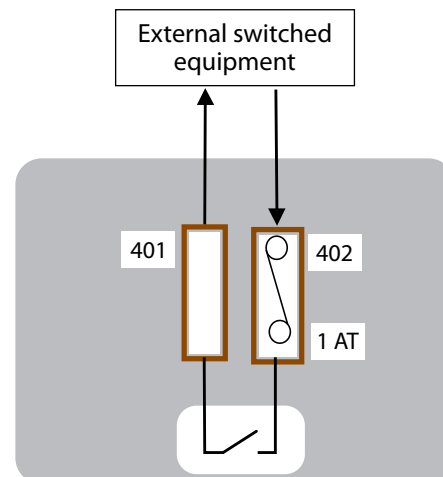

OUTPUT	FEED (FUSED) TERMINAL	RETURN TERMINAL
Output 1	402	401
Output 2	404	403
ETC.		

NB. Maximum switched load 1A at 24V AC/DC.

Maintenance

Mains terminal fuse replacements:

Panel sizes 1-3: 1AT 250 VAC

Panel sizes 4-5: 2AT 250 VAC

Output terminal fuse replacement: 1AT 250 VAC

Suggested replacement: Bussman S504 series.

Panel Network Wiring

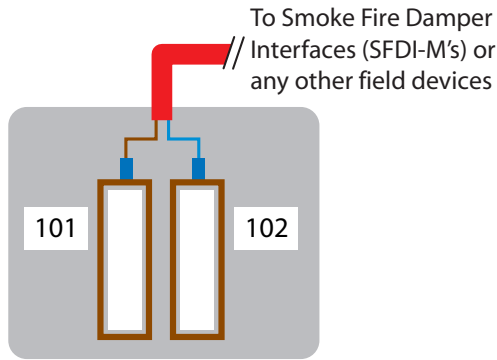

NETWORK	TERMINAL NUMBER
NETWORK 1	101, 102
NETWORK 2	103, 104
ETC.	

The network terminals are numbered 101, 102... these free topology networks are internally terminated.

Wire the first network as shown and repeat for subsequent networks.

Warning:

This is a life safety smoke/fire damper control & monitoring system and the network cables we supply are fundamental to the stable and reliable operation of the system.

Network Cable Rules:

1. All devices to be wired in a "daisy chain" i.e. in and out.
2. Standard network rules apply i.e. network cables must NOT be run alongside any high voltage and/or high frequency sources. If SFDI-M's are wired in areas of high voltage such as plant rooms/lift lobbies, network cable must be installed in dedicated conduit.
3. Network cable types must NOT be mixed on a cable segment. If extended a network cable it must be of the same type as the original cable.
4. Maximum TOTAL wire length for cable segment = 1000M.
5. Maximum number of SFDI-M on a network channel is 120.
6. SFDI-M's must be wired on a dedicated power supply.

Non Fire Rated Cable:

Belden 9841NH, 2 Core, 0.51mm² conductor size

Fire Rated Cable Options:

- Prysmian (Pirelli) FP200 Gold, 2 Core, 1.5mm²
- Prysmian (Pirelli) FP200 Plus, 2 Core, 1.5mm²
- Firetuf FT30, 2 Core, 1.5mm² conductor size
- Firetuf FT120, 2 Core, 1.5mm² conductor size

Field Network Wiring

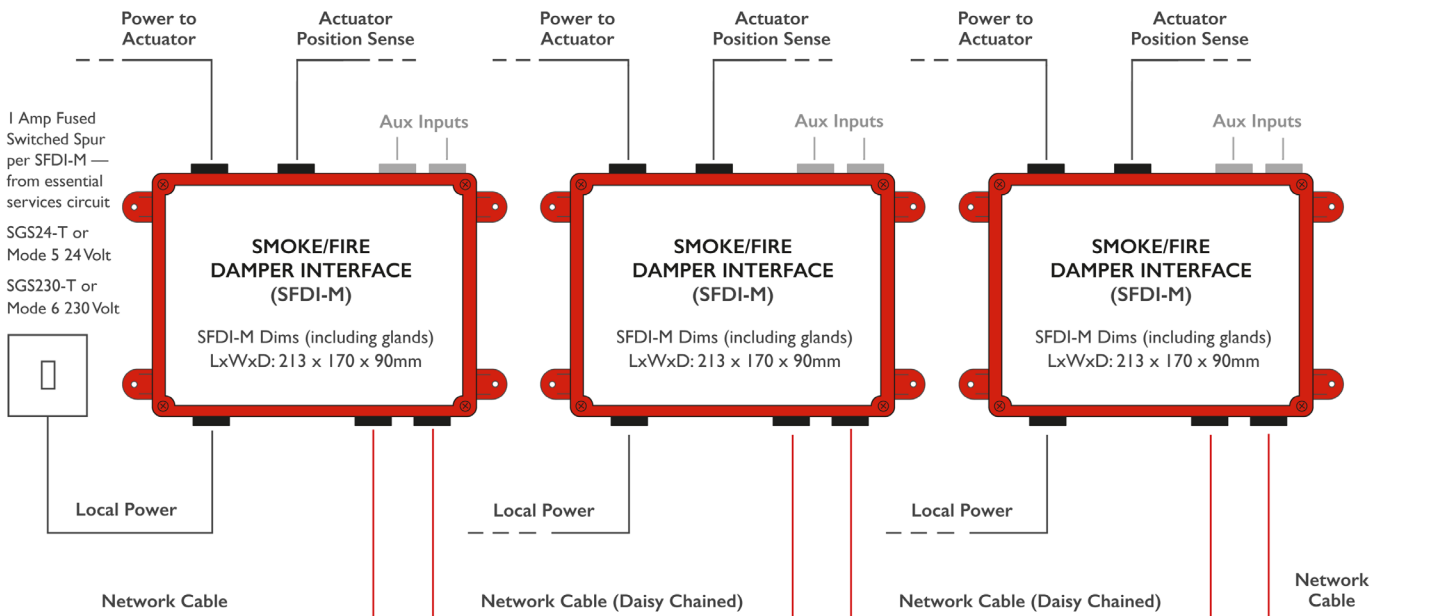

Specification

Supply

Input voltage	(230 ± 23) V AC, 50 Hz
Maximum power consumption	750 VA

Inputs

Contact type	Non-isolated dry contacts
Sense current	10 mA at 12 V DC

Outputs

Contact type	SPCO mechanical relay contacts
Maximum switched load	1A at 24 V AC/DC

Environmental

Operating temperature	0 °C to 40 °C
Storage temperature	-15 °C to 45 °C
Humidity	80 % RH to 31 °C decreasing linearly to 50 % RH at 40 °C
Maximum altitude	2000 m

Conformance

EMC	EN 55011: 2009+A1:2010
LVD	EN 61000-6-6: 2016 EN 61000-3-2: 2014 EN 61000-3-3: 2013

 Complies with European standards

WARNING: The responsible body shall be made aware that, if the equipment is used in a manner not specified by the manufacturer, the protection provided by the equipment may be impaired.

*The information herein is subject to change without notice. We do not assume any liability arising out of the use of this product. Purchase of goods and services is subject to Safegard Systems standard terms and conditions.
Product warranty 12 months from date of delivery.*

Actionair and Safegard are brand names of Swegon Air Management and Safegard Systems respectively and both companies are part of the Swegon Group.

Swegon Air Management, South Street, Whitstable, Kent, CT5 3DU, UK
T: 01227 276100 **F:** 01227 264262 **E:** sales@actionair.co.uk www.actionair.co.uk

actionair

Unit 33, Southern Cross Business Park, Bray, Co. Wicklow, A98 HT99, Ireland
T: +353 1 2761600 **F:** +353 1 2761611 **E:** info@safegard.ie www.safegard.ie

SAFEGARD SYSTEMS 
A Swegon Group company